

SMS GUIDED MISSILES, AERODYNAMICS, AND FLIGHT PRINCIPLES

Weapon systems consist of four major equipment areas—the Detect, Direct, Deliver, and Destroy units. For the last two chapters, we have concentrated on the Delivery units—the GMLSs. We will now discuss the units that Destroy—the guided missiles.

The purpose of this chapter is to familiarize you with the basic principles associated with guided missiles. We will study the major systems of a missile and learn why and how the missile flies. You should then be able to apply these basic principles to the missiles used in the surface missile system (SMS) in the fleet. Pay attention to the terminology of these new equipments.

STRUCTURE

LEARNING OBJECTIVE: Recall the basic structure of a missile to include its three primary sections.

Missiles, for the most part, are made up of several sections or shells (fig. 9-1). They are machined from metal tubing and contain the essential units or components of the missile. Sectionalized construction of a structure has the advantage of strength with simplicity. It also provides for easier replacement and repair of the components, since some sections are removable as separate units. The sections are joined by various types of connections which are also designed for simple operation. Covers and access doors are often installed on the outside of the structure to provide easy access to key interior components.

The missile exists to carry the warhead to the target. Therefore, the structure is designed around the size and weight of the warhead. The structure of the missile

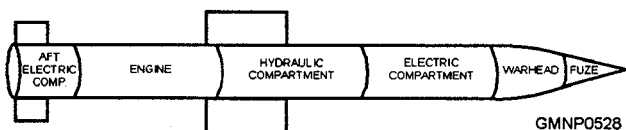

Figure 9-1.—Sectionalization of a missile.

must be as light and compact as possible, yet strong enough to carry all the necessary components. The structure must also be able to withstand the forces to which it will be subjected. These “forces” will be encountered during preflight shipping, handling, and stowage periods. Other forces, such as gravity, heat, pressure, and stresses of acceleration, will also be experienced in flight.

In most missiles, the main body is a slender, cylindrical structure capped on either end by nose and tail sections. Several types of nose sections can be used (fig. 9-2). If the missile is intended to fly at supersonic speeds (greater than the speed of sound), the forward (nose) section usually is designed with a pointed-arch profile. The sides taper in lines called “ogive” curves. With missiles intended for subsonic speeds, the nose is often not as sharp or even blunt. The forward section of most SMS missiles is covered by a “radome.” This type of nose protects a small radar antenna inside the missile.

Typical structures (airframes) contain a main body that terminates in a flat base or tail cone. When the contour of the tail cone is slightly streamlined at the rear, it is said to be “boattailed.” Attached to the body (also known as the skin or outer surface) are one or more sets of airfoils. These airfoils (wings, fins, or control surfaces) contribute to in-flight stability, provide lift, and control the flight path of the missile.

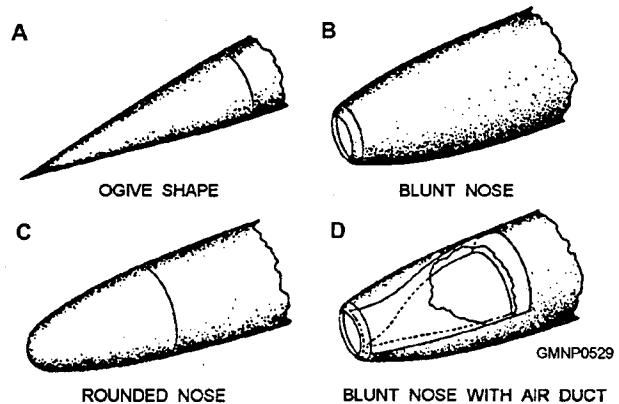

Figure 9-2.—Missile noses.

The design configuration of a particular missile depends on various factors. Consideration must be given to the speed, the operating range, and the turning rate of the missile. The purpose of the missile and the medium(s) through which the round will travel (such as water, air, or a combination of the two) are other important factors. The location of the primary control and/or lifting surfaces also determines the configuration of the missile. Two popular designs are wing-control and tail-control missiles (fig. 9-3). Wing-control airfoils are mounted at or near the center of gravity of the structure. Tail-control airfoils are located at the rear of the missile.

Most SMS missiles have dorsal fins and tail-control surfaces (fig. 9-4). The dorsal fins are attached to the main body of the missile. These stationary surfaces are used to provide stability and (some) lift during missile flight. The tail-control surfaces normally are folded during stowage. These surfaces are erected (unfolded) just before launch. The tail-control surfaces are turned or pivoted to control (steer) the missile along its flight path.

CONTROL

LEARNING OBJECTIVE: Recall the aerodynamic forces and basic motions that impact on the design and performance of a missile.

Before we examine the control system of a missile, it is important to understand a little about aerodynamics. Aerodynamics is the science that deals with the motion

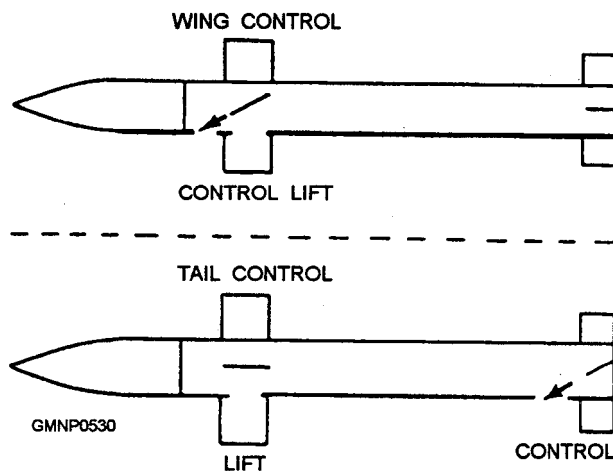

Figure 9-3.—Missile airframe design with respect to control surface location.

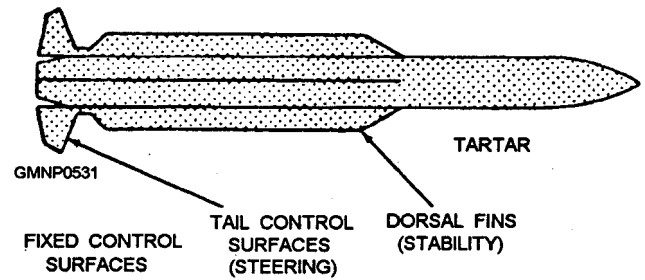

Figure 9-4.—Missile configurations.

of air and other gases. It also considers the forces acting on bodies moving through these gases. The principles of aerodynamics that apply to the operation of most aircraft also apply to high-speed missiles.

AERODYNAMIC FORCES

The principal forces acting on a missile in level flight are thrust, drag, weight, and lift. Like any force, each of these is a vector quantity that has magnitude and direction. These forces are shown in figure 9-5.

Thrust is directed along the longitudinal axis of the missile is the force that propels the missile forward at speeds sufficient to sustain flight.

Drag is the resistance offered by the air to the passage of the missile through it. This force is directed rearward.

Weight is comparable to the force of gravity acting on missile. This force is directed downward to the center of the Earth.

Lift is an upward force that supports the missile in flight. Lift opposes the force of gravity and is directed perpendicular to the direction of drag. Lift is the force that concerns us the most.

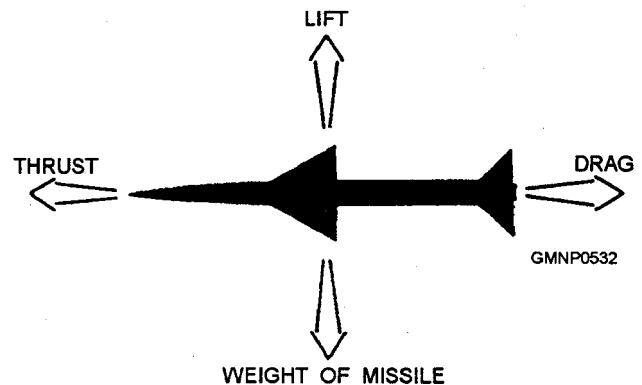

Figure 9-5.—Forces acting on a moving missile.

Lift is produced by means of pressure differences. The primary requirement for lift is that the air pressure on the upper surface of an airfoil (wing or fin) be less than the pressure on the underside. The amount of lifting force produced is dependent, to a large extent, on the shape of the airfoil. Additional factors also determine the amount of lift. The airfoil area and the angle at which its surface is inclined to an airstream affect lift. The air speed and air density passing around the airfoil are two more factors. The airfoil that provides the greatest lift with the least drag in subsonic flight has a curved (or camber) shape (fig. 9-6).

Some standard airfoil terms are also included in the drawing on figure 9-6. The foremost edge of the airfoil is the leading edge. The rear edge is the trailing edge. A straight line between the leading and trailing edges is the chord. The large arrow (in view B) indicates relative wind or the direction of airflow in respect to the moving airfoil. The angle of attack is the angle between the chord and the direction of relative wind.

As relative wind strikes the airfoils tilted surface, air flows around its upper and lower surfaces. Different amounts of lifting force are exerted on various points of the airfoil. The sum of all these forces is equal to a single force acting on a single point and in a particular direction. This point is the center of pressure. From here, lift is in a direction perpendicular to relative wind.

The dynamic or impact force of the relative wind against the airfoils lower surface contributes to lift. However, the major portion of the lifting force is obtained from the pressure differential above and below the airfoil. The angle of attack causes the air flowing over the airfoils upper surface to travel a greater distance. The farther the air has to travel, the faster it moves. Faster speed creates a lower pressure. Therefore, since the air pressure above the airfoil is less than that below it, the result is lift. The magnitude of the lifting force is proportional to the pressure difference.

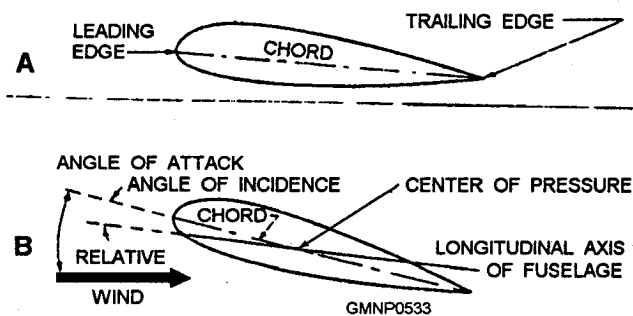

Figure 9-6.—Wing cross section.

BASIC MOTIONS

Like any moving body, a guided missile executes two basic types of motion—rotation and translation. In pure rotation, all parts of the missile pivot around the center of gravity. In movements of translation, or linear motions, the center of gravity moves along a line.

Missiles, like other aircraft, have six degrees or dimensions of freedom (movement). To describe these motions, we use a reference system of lines or axes. These axes intersect at the missile's center of gravity.

A missile can make three kinds of rotary movement—pitch, roll, and yaw (fig. 9-7). Pitch, or turning up and down, is rotation about the lateral axis. The lateral axis is the reference line in the horizontal plane and is perpendicular to the line of flight. The missile rolls, or twists, about the longitudinal axis. This axis is the reference line running through the nose and tail. The missile yaws, or turns left and right, about the vertical axis.

A missile can make three kinds of translation or linear movements. For example, a sudden gust of wind or an air pocket could throw the missile a considerable distance from its desired trajectory. This displacement could happen without causing any significant rotary or angular movements. Any linear movement can be resolved into three components—lateral, vertical, and along the direction of thrust.

The missile must sense and correct for each degree of movement to maintain an accurate and stable flight path. This stable flight path is often called "attitude" and refers to the position of the missile relative to a known (horizontal or vertical) plane. The control system contains various components used to maintain a proper flight attitude.

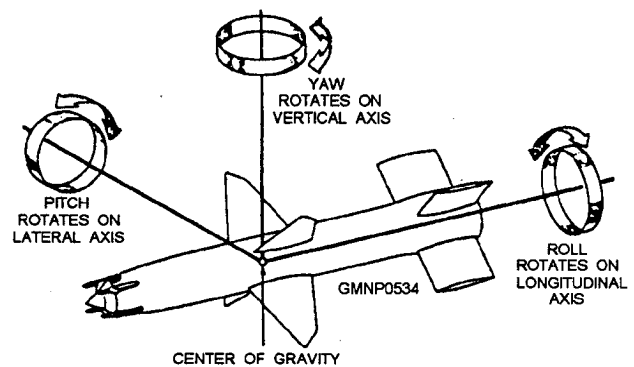

Figure 9-7.—Rotary movements of a missile: pitch, roll, and yaw.

Gyroscopes

Gyroscopes are very important control system components. Any spinning object (a top, a wheel, etc.) is fundamentally a gyro. It can be defined as a mechanical device containing a spinning mass. It is mounted in such a manner as to have either one or two degrees (directions) of freedom.

A gyro that has two degrees of freedom is referred to as a free gyro. Its rotor is mounted in gimbals so it can assume any position. View A of figure 9-8 shows a free gyro that can turn on two axes, Y and Z. View B shows a different type of gyro. It is called a rate gyro and has only one degree of freedom or axis.

Gyros have two useful characteristics in guided missiles. First, the gyro rotor tends to remain fixed in space if no force is applied to it. The idea of maintaining a fixed plane in space is easy to understand. When any object is spinning rapidly, it tends to keep its axis pointed in the same direction. A toy top is a good

example. As long as it is spinning fast, it stays balanced on its point. A gyro, like a spinning top, resists the tendency of gravity to change its spin axis. The resistance of a gyro against any force which tends to displace the rotor from its plane of rotation is called rigidity in space.

The second characteristic of a gyro is that its spin axis tends to move at right angles to the direction of an applied force. This action can be seen in figure 9-9. When a downward force is applied at point A, the force is transferred through pivot B. This force causes a downward movement at point C.

That movement, at a right angle to the direction of the applied force, is called precession. The force associated with this movement (also at right angles to the direction of the applied force) is called the force of precession.

Free Gyros in Guided Missiles

To see how free gyros are used in guided missiles to detect changes in attitude, refer to figure 9-10. Let us assume the missile shown in view A has a horizontal design attitude. A gyro within the missile has its spin axis in the vertical plane and is also gimbal-mounted. Any deviation in the horizontal attitude of the missile does not physically affect the gyro. In other words, the missile could roll and the gyro will maintain its position in space.

View B illustrates the last point. The missile has rolled about 30° but the gyro remains stable. If we could measure this angle, we would know exactly how far the missile deviated from the horizontal plane. This information could then be used to change the position of the control surfaces and correct or stabilize the

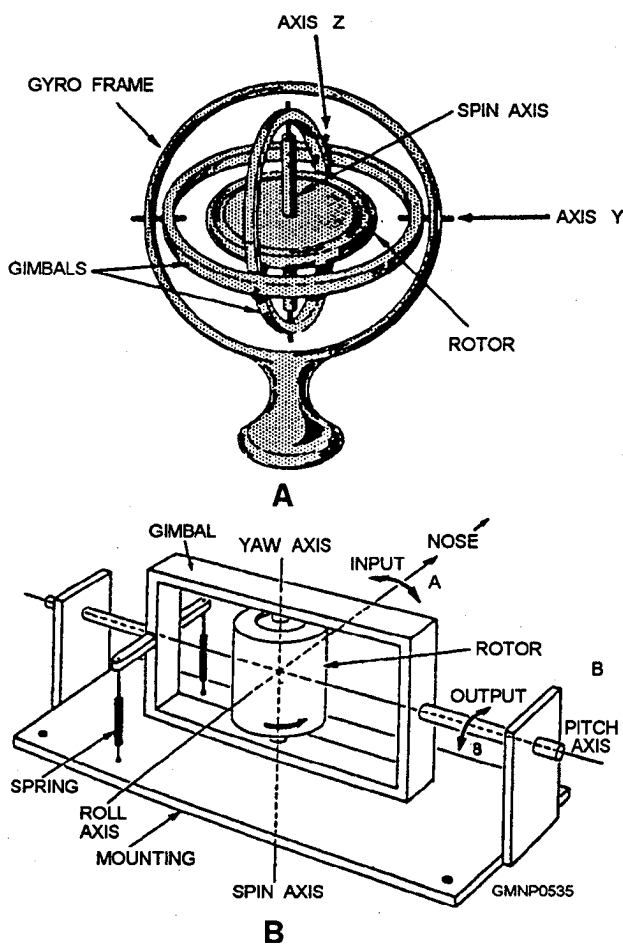

Figure 9-8.—Gyroscopes: A. Free gyro has two degrees of freedom, B. Rate gyro has one degree of freedom.

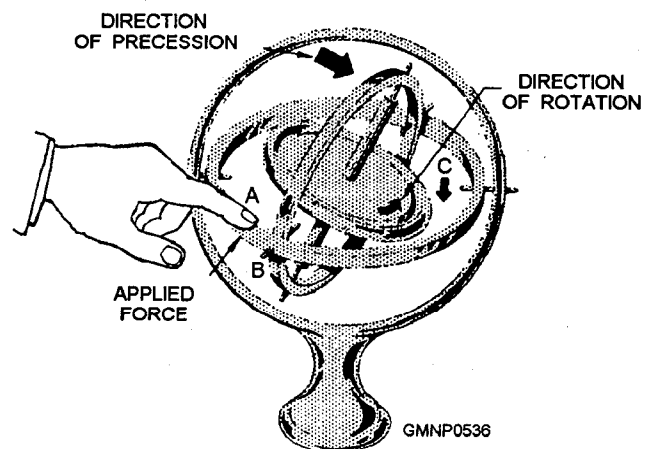

Figure 9-9.—Precessing a gyro.

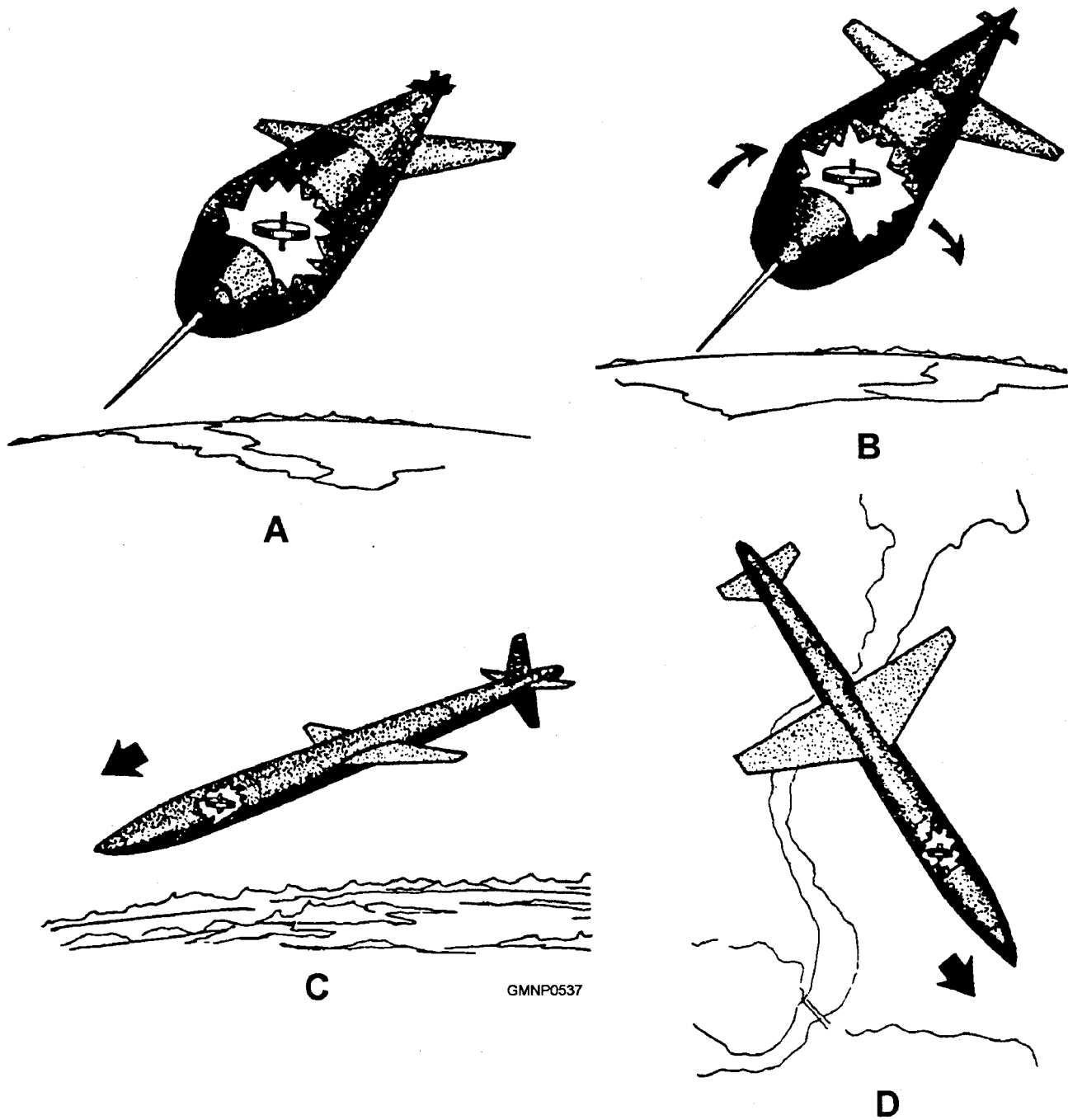

Figure 9-10.—View A.—missile horizontal; View B.—missile rolls; View C.—missile pitches; View D.—missile yaws. In all cases, gyro remains fixed in space.

missile. View C shows that a free gyro with a vertical spin axis can also be used to monitor or detect pitch.

Actually, a minimum of two free gyros is required to compensate for roll, pitch, and (the third factor) yaw. However, for yaw, a second gyro must be mounted so its spin axis is in the horizontal plane, as shown in view D. (You are looking down onto the missile.)

Rate Gyros in Guided Missiles

The free gyros just described measure and generate correction signals necessary to maintain a stable attitude. However, because of the momentum of the missile in responding to these signals, another problem develops. Large overcorrection would result unless

there were some way of determining how fast the angular movement is occurring. In other words, the missile would overshoot and oscillate around the given axis.

Rate gyros (shown in view B of fig. 9-8) take into account the momentum of the missile and continuously determine any angular accelerations. By combining the free and rate gyro signals, the tendency of the control surfaces to overcorrect is minimized and better in-flight stability is obtained. Normally, there is an independent rate gyro for each (roll, pitch, and yaw) axis.

CONTROL SURFACES

Aerodynamic control is the connecting link between the guidance system and the flight path of the missile. Effective control of the flight path requires smooth and exact operation of the control surfaces of the missile. They must have the best possible design configuration for the intended speed of the missile. The control surfaces must move with enough force to produce the necessary change of direction. The adjustments they make must maintain the balance and center of gravity of the missile. The control surfaces must also be positioned to meet variations in lift and drag at different flight speeds. All these actions contribute to the in-flight stability of the missile.

Stability and Lift

So far we have discussed the principles of producing lift by using chambered or curved airfoils. Chambered airfoils are mainly used on subsonic, conventional aircraft. The present-day supersonic guided missile must use a different kind of control surface to provide stability and lift.

In most SMS missiles, lift is achieved almost entirely by the thrust of the propulsion system of the missile. The control surfaces must, therefore, be streamlined to reduce any resulting air turbulence. The lift that a missile fin does contribute is based on a slightly different principle than that seen in figure 9-6. At subsonic speeds, a positive angle of attack on the fins of the missile will produce lift just as with the conventional airfoil. However, at supersonic speeds, the formation of expansion waves and oblique (angled) shock waves also contribute to lift.

View A of figure 9-11 shows the upper surface of a supersonic fin in detail. Because of the shape of the fin, the air is speeded up through a series of expansion waves, resulting in a low-pressure area above the fin. View B of figure 9-11 shows a full cross section of the

fin. Beneath it, the force of the airstream and the formation of oblique shock waves results in a high-pressure area. These pressure differences produce lift.

Fin Designs and Arrangements

Figure 9-12 shows the basic design shapes of supersonic fins. In view A, the double wedge offers the least drag but lacks strength. The modified double wedge has relatively low drag and is stronger. The biconvex causes considerable drag but is the strongest of the three designs. The biconvex is also the most difficult and expensive to manufacture.

View B of figure 9-12 shows the side view of popular supersonic fin designs. These particular shapes are used to reduce unwanted shock wave effects.

Fins can be mounted on the structure of the missile in many different arrangements. Figure 9-13 shows some of the variations. The cruciform style is the most predominant in SMS missiles.

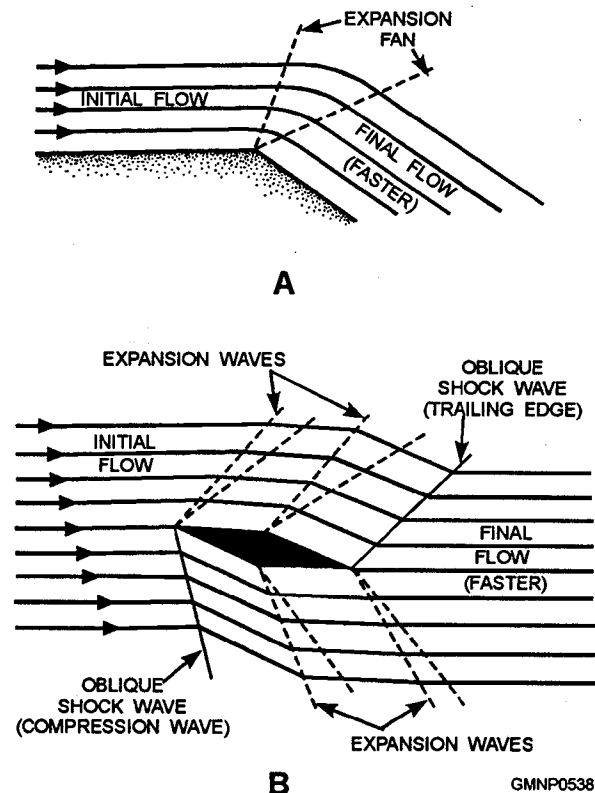

Figure 9-11.—View A.—expansion wave; View B.—airflow around a supersonic fin.

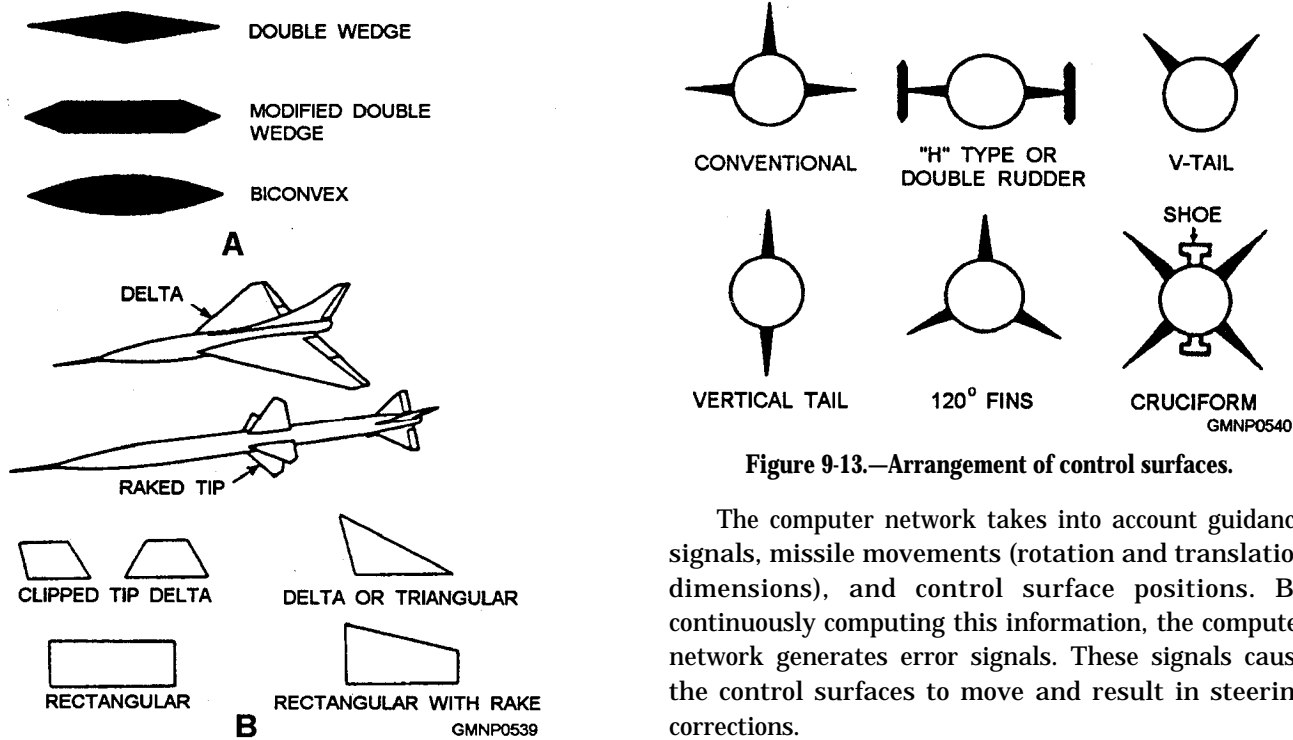

Figure 9-12.—High-speed fin configurations.

External Control

Guided missiles are equipped with two types of control surfaces. The stationary (dorsal) fins provide for in-flight stability and some lift. The movable control surfaces (tail control surfaces) provide the necessary steering corrections to keep the missile in proper flight attitude and trajectory.

TYPES OF CONTROL SIGNALS.— The basic control signals may come from inside the missile, from an outside source, or both. To coordinate these signals, the missile has onboard computers to mix, integrate, and rate the control signals.

Figure 9-13.—Arrangement of control surfaces.

The computer network takes into account guidance signals, missile movements (rotation and translation dimensions), and control surface positions. By continuously computing this information, the computer network generates error signals. These signals cause the control surfaces to move and result in steering corrections.

Does the information in the last paragraph sound familiar-kind of like a servo system? Well, it should because guided missiles use servo systems/servomechanisms that are very similar to those we discussed with GMLS power drives.

CONTROL SYSTEM OPERATION.— A block diagram of a basic missile control system is shown in figure 9-14. Free gyroscopes provide inertial references from which missile attitude can be determined. For any particular attitude, gyro signals are sent from the gyroscope sensors to the summing network of the computer. These signals are proportional to the amount of roll, pitch, and yaw at any given instant.

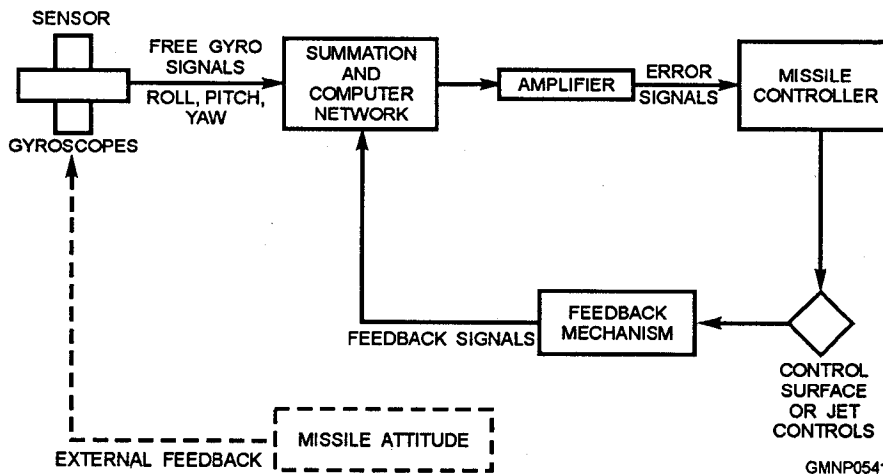

Figure 9-14.—A basic missile control system (servo).

After the gyro signals are compared with other information (e.g., guidance signals), correction signals are generated. These signals are orders to the controller servo and are used to position the control surfaces.

In addition to the internal feedback (response), an external feedback feature is present. Because the gyroscopes continuously detect changes in missile attitude, they are always producing an output order.

GUIDANCE

LEARNING OBJECTIVE: Recall the purpose and functions of missile guidance systems to include the phases of guidance and the various types of guidance systems.

The guidance and control functions of a missile are often confused as being the same. Well, they are in one sense and are not in another. A guidance system is used to keep the missile on its proper flight path (trajectory) and headed toward the target. The guidance system can be thought of as the brain of the missile. The control system performs two distinct tasks. First, it maintains the missile in proper flight attitude. Using instruments like gyros, the control system corrects for problems experienced through rotation and translation. Second, the control system responds to orders from the guidance system and steers the missile toward the target. Think of the control system as the muscle of the missile.

Therefore, the guidance and control systems DO work together to (1) determine the flight path of the missile and (2) maintain the missile in proper flight attitude (stability). Four processes are involved with these combined operations:

1. **Tracking**— the positions of the target and missile are continuously determined.
2. **Computing**— the tracking information is used to determine the directions necessary for control.
3. **Directing**— the directions or correcting signals are applied to the controlling units.
4. **Steering**— using the correcting signals to direct the movements of the control surfaces.

The first three processes are performed by the guidance system of the missile. The fourth process, steering, is accomplished by the control system of the missile.

Figure 9-15 is a simple block diagram of a basic guidance system. This system is very similar to a basic control system shown in figure 9-14. The two systems interrelate and interact in their operations.

PHASES OF GUIDANCE

Generally, missile in-flight guidance is divided into three phases—boost, midcourse, and terminal. These names refer to the different parts or time periods of a trajectory (fig. 9-16).

Boost Phase

The boost phase of missile flight is also known as the launching phase or initial phase. It is during this period that the missile is boosted to flight speed. It lasts until the fuel supply of the booster burns up. For the medium-range (MR) missiles that use a dual-thrust rocket motor (DTRM), the booster propellant grain is consumed and burns out. For extended range (ER) missiles, the separate booster drops off at burnout.

The boost phase is very important to the flight path of the missile. The launcher and missile are aimed in a specific direction by orders from the FCS computer. This aiming establishes the line of sight (trajectory or flight path) the missile must fly along during the initial phase. At the end of boost, the missile must be at a calculated point. Some missiles are guided during boost; others are not.

Midcourse Phase

The second or midcourse phase of guidance is often the longest in both distance and time. During midcourse (or cruise) guidance, the missile makes any corrections necessary to stay on the desired course.

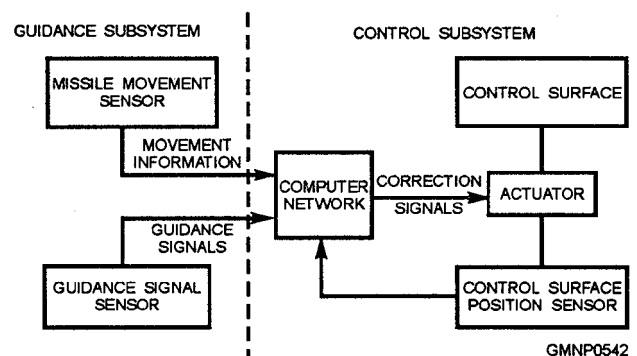

Figure 9-15.—Basic missile guidance system.

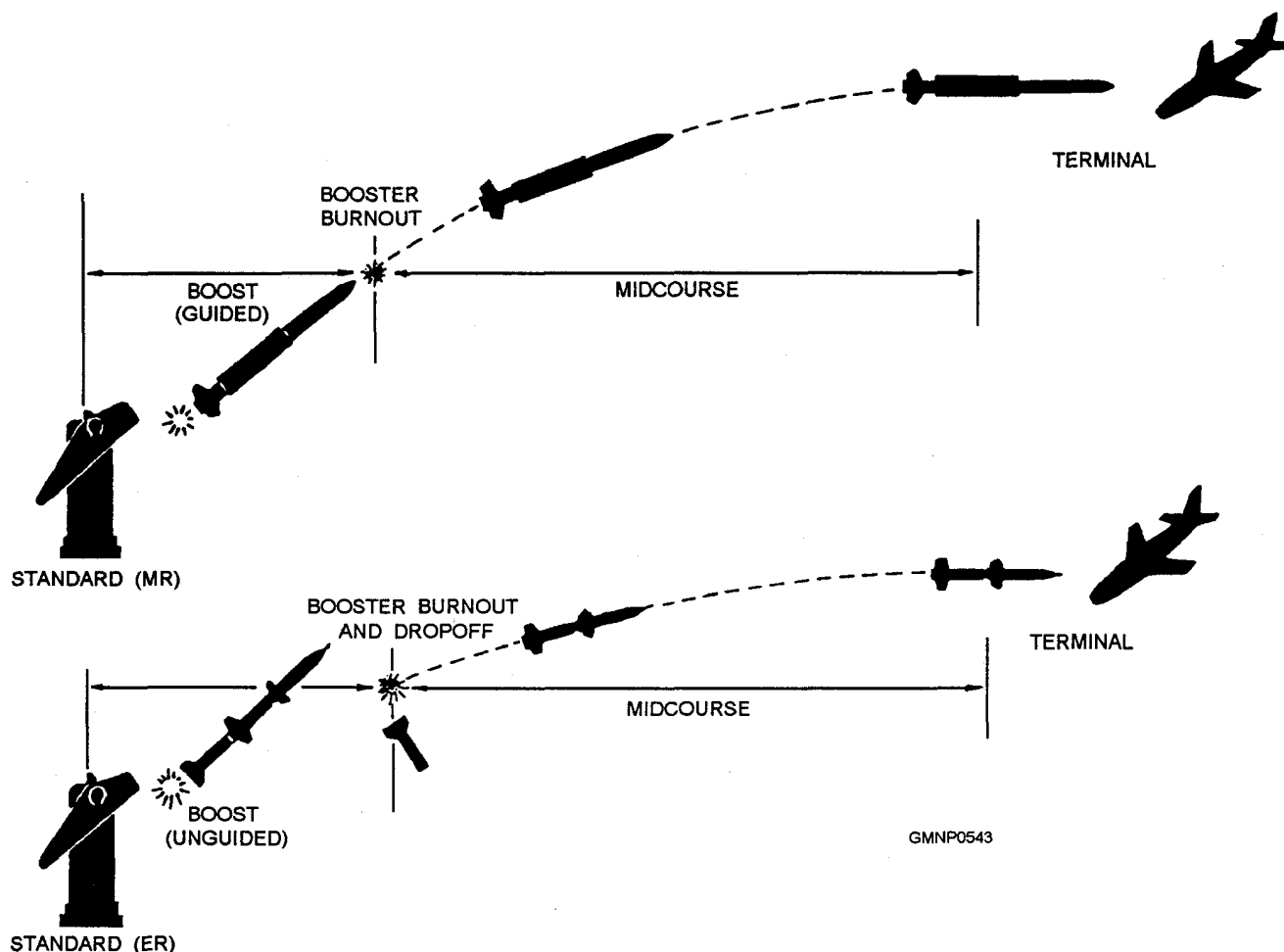

Figure 9-16.—Guidance phases of flight.

Guidance information can be supplied to the missile by various means. The object of midcourse guidance is to place the missile near the target.

Terminal Phase

The terminal phase of guidance brings the missile into contact or close proximity with the target. The last phase of guidance must have quick response to ensure a high degree of accuracy. Quite often the guidance system causes the missile to perform what is best described as an “up-and-over” maneuver during the terminal phase. Essentially, the missile flies higher than the target and descends on it at intercept.

We will now discuss the various types of guidance systems and how they direct the missile to the target. The four main categories are (1) command, (2) homing, (3) composite, and (4) self-contained.

COMMAND GUIDANCE SYSTEMS

Command guidance missiles are those which are guided on the basis of direct electromagnetic radiation contact with a friendly source (i.e., ship, ground, or aircraft). All guidance instructions, or commands, come from outside the missile. The guidance sensors detect this information and convert it to a usable form. The output of the guidance computer initiates the movement of the control surfaces and the missile responds.

There are (or were) various types of command guidance methods. Early examples included remote control by wire and by radio command. Generally command by (believe it or not) wire was limited to air-launched missiles. A pair of fine wires was unrolled from coils after the missile was launched. The airplane pilot mentally calculated and manually controlled the trajectory of the missile to the target. Radio command eliminated wires and extended the range of a missile.

However, one solution always leads to another problem. Radio command was effective as long as the operator could see the missile. After it flew beyond the range of normal vision . . . well, you can understand the problem if you have ever owned a remote-controlled model airplane. From wire, to radio, to the next logical method—radar.

In the radar command guidance method, radar is used to track the missile and the target. Guidance signals are sent to the missile by varying the characteristics of the missile radar tracking beam. Sometimes a separate radio transmitter is used.

Figure 9-17 shows the basic arrangement of radar command guidance. As soon as radar #1 (target tracker) is locked on target, tracking information is fed to the computer. The missile is launched and tracked by radar #2 (missile tracker). Data from both target and missile radars, such as ranges, elevations, and bearings, are fed continuously into the computer. The computer analyzes the data and determines the correct flight path for the missile. The guidance signals or commands generated by the computer are routed to a command (radar or radio) transmitter and sent to the missile. The receiver of the missile accepts the instructions, converts them, and directs the control surfaces to make steering corrections.

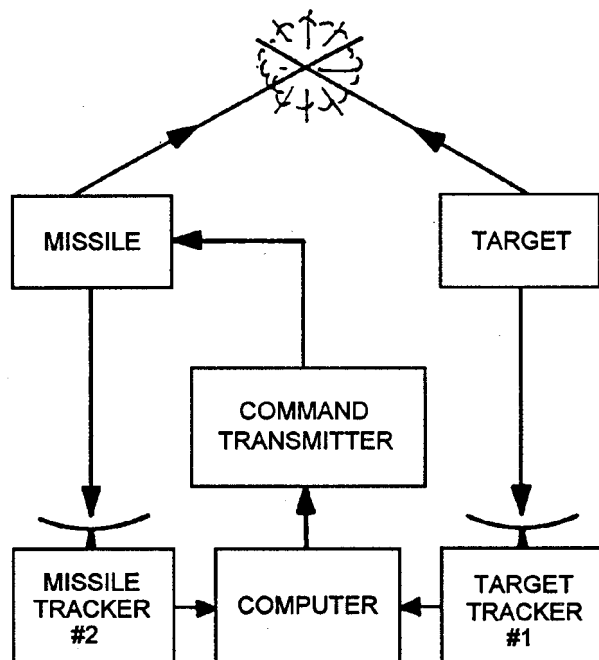

Figure 9-17.—Basic radar command guidance.

HOMING GUIDANCE SYSTEMS

Homing guidance systems also rely on electromagnetic radiations for guidance information. The homing device is usually a small antenna located within the nose of the missile. It detects some type of distinguishing feature or radiation given off by or reflected from the target. This information is converted into usable data and positions the control surfaces. Three types of homing guidance systems are used by SMS missiles—active, semiactive, and passive.

Active Homing Guidance

In active homing guidance (view A of fig. 9-18), the missile contains an onboard transmitter and receiver. The transmitter sends out radar signals in the general direction of the target. These signals strike the target and reflect or bounce back to the missile. These return “echoes” are picked up by the receiver antenna of the missile and fed to the guidance computer. The computer output generates steering corrections for the control system. Active homing guidance does not require a ship's radar; the missile is entirely on its own after launch.

Semiactive Homing Guidance

In semiactive homing guidance (view B of fig. 9-18), the missile contains only a receiver (referred to as a seeker head or signal antenna). The ship's fire control radar serves as the transmitting source and directs its radar energy to illuminate the target. As in active homing guidance, part of this energy is reflected or bounced from the target. The receiver of the missile picks up the reflected energy and uses it to generate its own steering commands.

Passive Homing Guidance

The passive homing guidance method (view C of fig. 9-18) depends on the missile's detecting some form of energy emitted by the target. A receiver antenna inside the missile picks up this “signal” and computes all necessary guidance information. Steering corrections are made and the missile homes in on the target.

Passive homing guidance, like active homing, is completely independent of the launching ship. Passive homing normally is not used to guide the missile all the way (from launch to intercept). However, it is well adapted to serve as a secondary or backup guidance system. Should the enemy sense any radar illumination

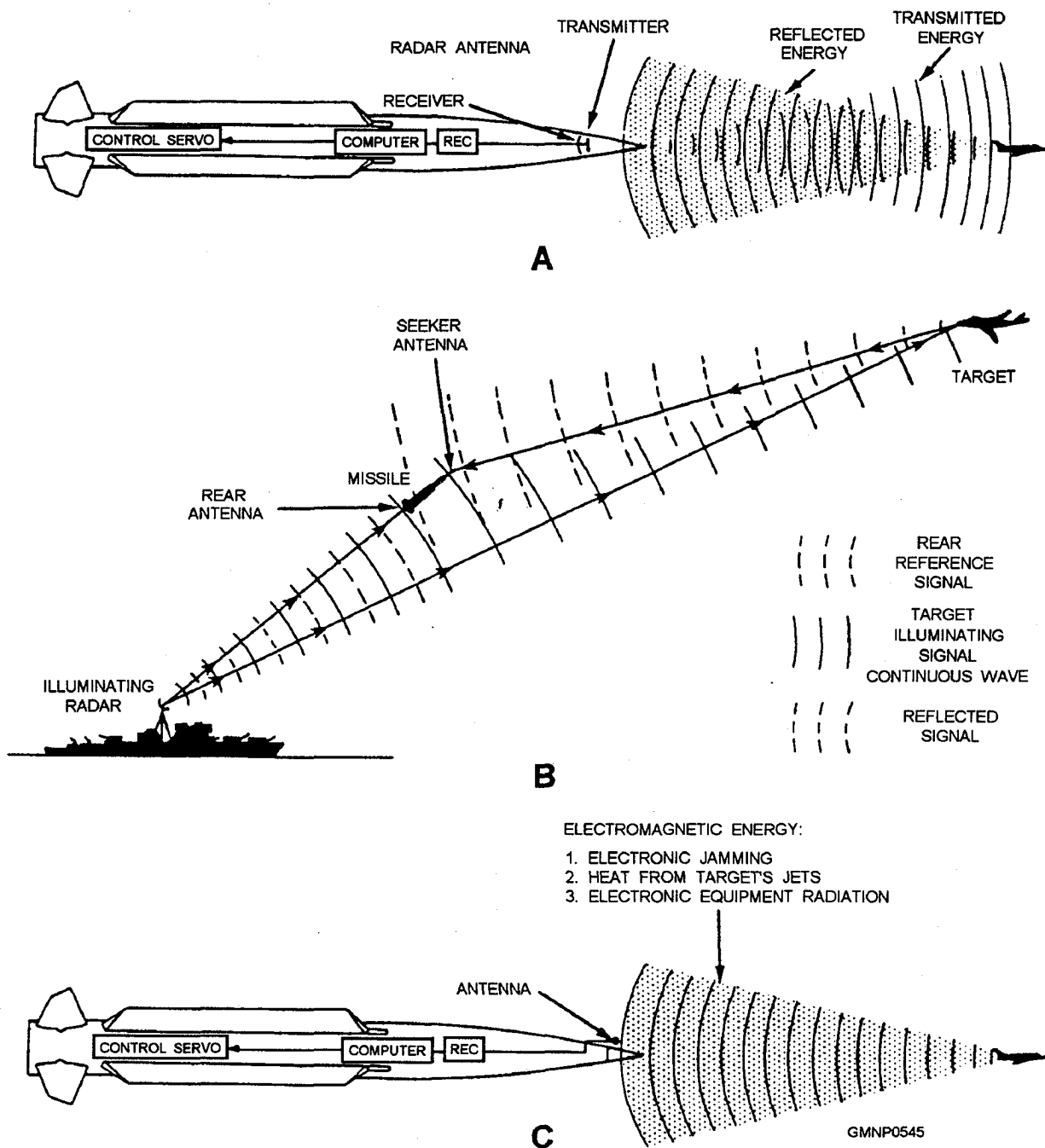

Figure 9-18.—Homing guidance system: A. Active; B. Semiactive; and C. Passive.

(such as from active and semiactive homing methods), electronic jamming could be initiated. This jamming “mixes” up the guidance information to the missile. Sensing the jamming, circuits within the guidance system of the missile switch over to passive mode. The missile continues toward the target, homing on the jamming source. Other sources of energy used for passive homing can include light, sound, heat from a propulsion unit, and so forth.

COMPOSITE GUIDANCE SYSTEMS

There isn't any one type of guidance system (command or homing) best suited for all phases of guidance. Therefore, it is logical to design one guidance system that combines the advantages of the others. For example, a missile may ride a signal until it is within a certain range of the target. At this point, the signal is terminated and a type of homing guidance takes over until intercept.

Control of a particular guidance subsystem may come from more than one source. A signal is setup to designate when one phase of guidance is over and the next phase begins. This signal may come from a tape, an electronic timing device, or from a radio or radar command.

The device that switches guidance subsystems is often called a control matrix. It automatically transfers the correct signal to the guidance subsystem regardless of conditions. If the midcourse subsystem should fail, the matrix switches in an auxiliary subsystem. Should the original guidance subsystem become active again, the matrix switches back to the primary subsystem.

SELF-CONTAINED GUIDANCE SYSTEMS

Certain guided missiles have self-contained guidance systems. All guidance and control functions are performed totally within the missile. They neither transmit nor receive any signals during flight. Therefore, jamming or other electronic countermeasures are ineffective against them. Generally, self-contained guidance systems are used in surface-to-surface or shore applications.

Preset Guidance

The term *preset* completely describes this method of guidance. Before the missile is launched, all the information relative to target location and the required missile trajectory must be calculated. The data is then locked into the guidance system so the missile will fly at correct altitude and speed. Also programmed into the system are the data required for the missile to start its terminal phase of flight and dive on the target.

One disadvantage of preset guidance is that once the missile is launched, its trajectory cannot be changed. Therefore, preset guidance is really only used against large stationary targets, such as cities.

Navigational Guidance Systems

When targets are at very great distances from the launch site (beyond the effective range of radar, for example), some form of navigational guidance must be used. Accuracy at these distances requires exacting calculations and many complicated factors must be considered. Three types of navigational guidance systems that may be used by long-range missiles are inertial, celestial, and terrestrial.

INERTIAL GUIDANCE.— The inertial guidance method is similar to the preset guidance method. Inertial guided missiles also receive preprogrammed information before launch. After launch, there is no electromagnetic contact between the missile and its launch point (the ship, in our case). However, unlike preset guidance, the missile can make corrections to its flight path and does so with amazing accuracy.

Flight control is accomplished by using special sensors, called accelerometers, mounted on a gyro-stabilized platform. All in-flight accelerations are measured continuously and the guidance and control systems generate steering orders to maintain the proper trajectory. The unpredictable outside forces (e.g., wind) are also monitored by the sensors. Correction orders are generated to maintain proper flight attitude.

The use of an inertial guidance system takes much of the guesswork out of the long-range fire control problem. It has proven to be extremely reliable and, above all, very accurate.

CELESTIAL GUIDANCE.— A celestial guidance system uses stars or other celestial bodies as known references (or fixes) in determining a flight path. This guidance method is rather complex and cumbersome. However, celestial guidance is quite accurate for the longer ranged missiles.

TERRESTRIAL GUIDANCE.— Terrestrial guidance is also a complicated arrangement. Instead of celestial bodies as reference points, this guidance system uses map or picture images of the terrain which it flies over as a reference. Terrestrial and celestial guidance systems are obviously better suited for large, long-range land targets.

PROPULSION

LEARNING OBJECTIVE: Recall the types of missile propulsion, engines, and fuels, the affects of acceleration, and the four associated speed regions.

“Propulsion” is defined as the act of driving forward or onward by means of a force that imparts motion. Considering all the different types of weapons, there are three methods of propulsion:

1. Gun or impulse
2. Reaction
3. Gravity

Any weapon that uses an internal source of propulsive power to carry it to a target is said to be a reaction-propelled weapon. Guided missiles are reaction-propelled weapons. The propelled power is obtained from the combustion of a fuel in a reaction motor.

REACTION PROPULSION

The basic principle of reaction propulsion can be summarized by the old law of physics that states, “for every action, there is an equal and opposite reaction.” A person walks forward by pushing backward against the ground. A missile moves forward when a mass of gas (a jet) is expelled rearward at high speed.

Jet propulsion is another term that describes reaction propulsion. Jet propulsion is a means of locomotion obtained from the momentum of matter ejected from within a body. This matter must be in the form of a fluid jet. The fluid can be water, steam, heated air, or gaseous products produced from burning a fuel. For our purposes, jet propulsion systems used in guided missiles may be divided into two types—thermal jet engines and rocket engines. Both types operate by expelling a stream of high-speed gas from an exhaust nozzle.

Thermal Jet Engines

Missiles with thermal jet engines “breathe” in a predetermined amount of air and compress it. Liquid fuel is then injected into the compressed air and the mixture is ignited. Combustion takes place within a combustion chamber. The resulting hot gases are expelled through an exhaust nozzle at the rear of the missile. At this point, heat energy is transformed into kinetic energy and the thrust or propulsive motion is created.

An air-breathing jet engine must rely on oxygen obtained from the atmosphere for fuel combustion to take place. That is a disadvantage because the flight altitude (or ceiling) of the missile is thereby limited. However, at lower altitudes, the air-breathing (thermal) jet engine is very efficient.

Rocket Engines

A rocket (jet) engine does not depend on air intake for its operation. Hence it is capable of functioning at very high altitudes and even beyond the atmosphere. A rocket engine carries within it all the materials required for combustion. That usually includes a fuel, either solid or liquid, and an oxidizer. The oxidizer is a substance capable of releasing the oxygen that is necessary to support combustion.

Once the propellant of the rocket engine is ignited, hot gases are expelled from the exhaust nozzle. Heat energy is changed to kinetic energy and thrust is created. The amount of thrust developed by a rocket-type engine generally is rated as extremely high compared to the thrust of a similar sized air-breathing engine.

The more important characteristics of all rocket motors are summarized below.

1. The thrust developed by a rocket motor is very high, nearly constant, and is independent of missile speed.
2. Rockets will operate in a vacuum.
3. Rockets have relatively few moving parts and simple design.
4. Rockets have a very high rate of propellant consumption.
5. Essentially the burning time of a rocket propellant is short.
6. Rockets need no booster since they develop full thrust at takeoff. If a booster is used, it aids the missile in reaching flight speed in minimum time and can extend range.

We’ll now discuss two types of reaction/jet propulsion units used in SMS missiles. First, we’ll examine a thermal jet-type engine known as a turbojet. Then we’ll cover solid-fuel rocket motors which are classified as rocket engines.

TURBOJET ENGINES

A turbojet engine is an air-breathing, thermal jet propulsion system. It is called a turbojet because a portion of its exhaust is used to operate a turbine. The turbine, in turn, drives an air compressor. The primary function of a compressor is to receive and compress large masses of air. It then distributes this air to the combustion chambers.

Therefore, the major areas of a turbojet engine are an air intake system, an air compressor, a combustion chamber, and a turbine. These components essentially form an open-cycle gas turbine combined with a jet stream. In operation, the compressor is driven by the gas turbine, as shown in figure 9-19. It supplies air under high pressure to the combustion chamber. The turbine absorbs only part of this energy while the rest is used for thrust. Once the engine is started, combustion is continuous.

The turbojet does have one minor disadvantage. Its speed is limited to less than the speed of sound. If it approaches that point, shock waves develop on the compressor blades and interfere with engine operation/efficiency.

SOLID-FUEL ROCKET MOTORS

Although there are solid- and liquid-fuel rockets, the majority of SMS missiles have solid-fuel rocket motors. The major elements of such propulsion units include (1) propellant, (2) combustion chamber, (3) igniter or squib, and (4) exhaust nozzle (fig. 9-20).

The combustion chamber of a solid-fuel rocket has two purposes. First, it acts as a stowage place for the propellant. Second, it serves as the area where burning takes place. Depending on the grain configuration used, this chamber may also contain a device to hold the propellant in a certain position. A trap of some sort may be included to prevent flying particles of propellant from clogging the throat of the exhaust nozzle. Additionally, the chamber may have resonance rods. They absorb vibrations set up in the chamber during burning.

The igniter consists of a small explosive charge, such as black powder or a comparable material. The substance is easily ignited by either a spark discharge

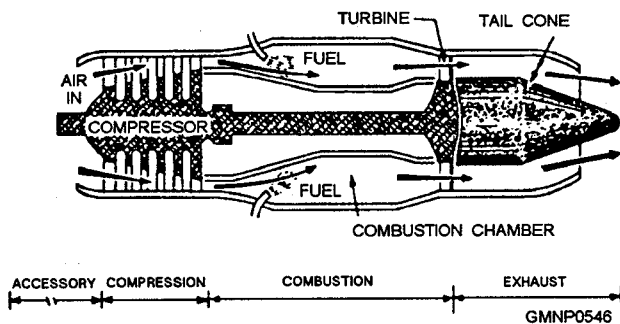

Figure 9-19.—Cross-sectional view of a basic turbojet.

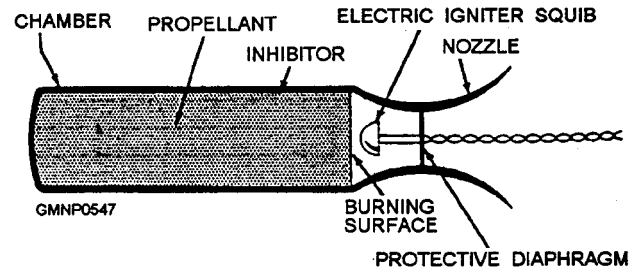

Figure 9-20.—Components of a solid-fuel rocket motor, with end burning grain.

or small electric current. As it burns, the igniter produces a temperature high enough to activate the main propellant charge. The igniter is sometimes known as a primer or a squib.

The exhaust nozzle serves the same purpose as in any other jet-propulsion system. It must be of heavy construction and heat-resistant due to the high pressures and temperatures of the exhaust gases.

Operation of a solid-fuel rocket is simple. To start the combustion process, the igniter or electric squib is "fired to initiate the main propellant. You get a cloud of smoke, a pretty loud roar, and a rail-clear indication!

Types of Solid Propellants

There are two basic types of solid-propellant charges—restricted burning and unrestricted burning. A restricted-burning charge has some of its exposed surfaces covered with a liner or inhibitor (view A in fig. 9-21). This covering confines the burning area and aids

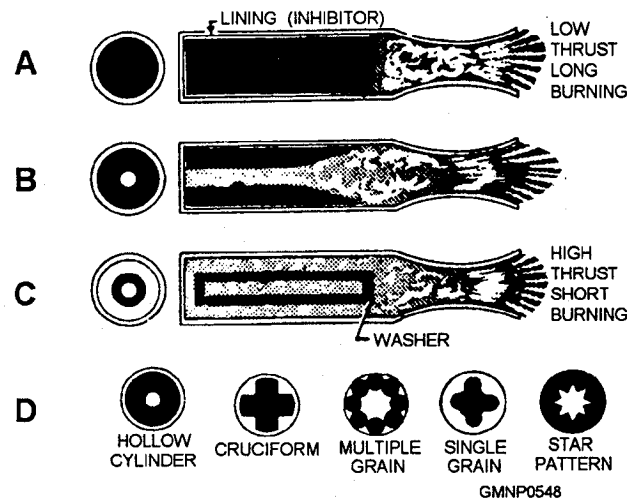

Figure 9-21.—Solid propellant grains: A. Restricted burning; B. Restricted bored; C. Unrestricted burning; D. Grain patterns.

in controlling the burning rate of the propellant. The use of an inhibitor lengthens burning time and helps to control combustion-chamber pressure.

A restricted-burning charge is usually in the shape of a solid cylinder. It completely fills the combustion chamber and burns only on its end. The thrust developed is proportional to the cross-sectional area of the charge. Burning time is proportional to the charge length. The restricted-burning charge provides a low thrust and long burning time. Normally, it is used in the sustainer section of the propulsion system of the missile.

Unrestricted-burning charges are designed so they bum on all surfaces at once. The charge is usually hollow and bums on both the inside and outside surfaces. (See view C of fig. 9-21.) Since the inside area increases while the outside area decreases during combustion, a constant burning area is maintained.

For an unrestricted-burning charge, thrust is also proportional to the burning area. The burning time of hollow grains depends on their web thickness. That is the distance between the inside and outside surfaces. An unrestricted-burning charge delivers a lot of thrust for a short period of time. It normally is used in the booster section of the propulsion system of the missile.

Certain SMS missiles use a separate missile-booster combination. The solid-fuel booster, using an unrestricted-burning charge, provides the initial large thrust for a short period of time. In doing so, it gets the missile off the launcher rail, up to flight

speed quickly, and extends the range of the weapon. The solid-fuel sustainer of the propulsion system of the missile uses a restricted-burning charge. It is ignited at booster separation and provides the low thrust, long burning time to “sustain” or keep the missile going down range.

Other types of SMS missiles use what is called a dual-thrust rocket motor (DTRM) (fig. 9-22). The solid-fuel propulsive charge is formed by bonding two types of propellants into a single unit. The center (booster) grain is an unrestricted charge and boosts the missile into flight. The outer (sustainer) grain is a restricted charge and sustains the missile until the end of flight.

Burning Rate of Solid Propellant Grains

The key point to understand about the restricted and unrestricted charges is that their burning rate is controlled. An uncontrolled burning rate would result in an explosion. That is fine for the warhead which we'll discuss next, but for a rocket motor. . . it could really ruin a paint job on the launcher.

The ideal solid-propellant would be ignited easily and continue to bum evenly. However, “ideal” is not possible. One way to control a burning rate is to use an inhibitor. An inhibitor is any substance that interferes with or retards combustion. The lining and washer shown in views A and C, respectively, of figure 9-21 are two examples of inhibitors.

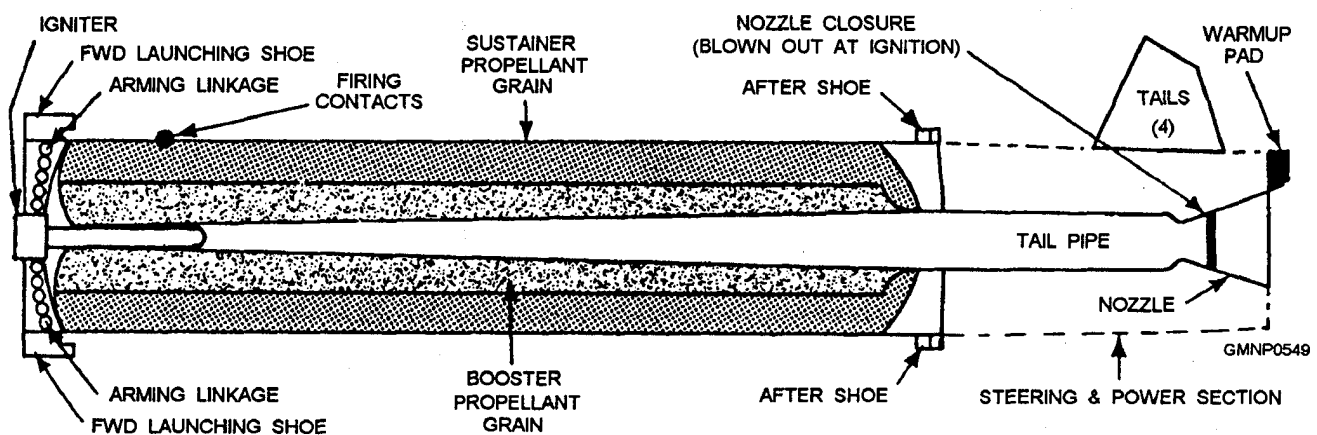

Figure 9-22.—Cutaway view of a dual-thrust rocket motor.

another method of controlling the burning rate of a propellant is to use various grain shapes. Common examples of these shapes are shown in view D of figure 9-21. Resonance rods, mentioned earlier, may be used to offset the resonant burning or “chugging” of a propellant. These metal or plastic rods are sometimes included in the combustion chamber. They serve to breakup regular fluctuations in the burning rate and accompanying pressure variations. They do so by maintaining a constant burning area while the surface of the grain is being consumed.

The burning characteristics of a solid propellant depend on various factors. Examples include its chemical composition, initial temperature, size and shape of the grains, and so forth. In most missiles, the propellant is case-bonded to the combustion chamber walls. This bonding means the propellant composition is melted and then poured or cast directly into the chamber. This technique makes full use of the entire chamber area.

One limitation to solid-fuel propellants is their sensitivity to temperature changes. The burning rate of the propellant can be affected. A particular grain may produce more thrust on a hot day than it will on a cold day. Now, this doesn't mean you can't fire missiles on your next North Atlantic cruise (for you East Coast Sailors). However, it is a factor to be considered in the fire control problem.

Temperature also affects the physical state of a solid-fuel propellant. At extremely low temperatures, some grains become brittle and tend to crack. Cracks increase the burning area surface leading to an increased burning rate and combustion-chamber pressure. If the pressure exceeds the design strength of the chamber, the missile could explode. Cracks in the propellant grain resulting from the missile being dropped or jarred during handling will have the same effect-explosion.

High temperatures can make certain grains lose their shape and become soft and weak, possibly resulting in unsatisfactory performance. The optimum temperature ranges for most solid propellants in stowage is between 70°F and 100°F.

ACCELERATION

Since we are in the area of propulsion, it is appropriate to talk about acceleration as it affects a missile. Acceleration is a change in either speed or direction of motion. A missile experiences the forces of acceleration as it increases or decreases speed during flight. Changes in direction, dives, pullouts, and so forth, are also acceleration forces acting on a missile.

These forces are measured in terms of the standard unit of gravity. This unit is abbreviated by the letter *g*. A free-falling body is attracted to Earth by a force equal to its weight. As a result, it accelerates at a constant rate of about 32 feet per second. That is equal to one *g*. Missiles, making rapid turns or responding to major changes in propulsive thrust, experience accelerations many times that of gravity. The maximum *g*-force a missile can withstand determines the maximum turning rate of the weapon.

MACH NUMBERS AND SPEED REGIONS

Missile speeds are expressed in terms of Mach number, rather than miles per hour or knots. A Mach number is the ratio of missile speed to the local speed of sound. If a missile is flying at one half of the local speed of sound, it is traveling at .5 Mach; twice the local speed of sound is Mach 2.

Notice that we have referred to the “local” speed of sound. That is because this quantity is not fixed or constant. The speed of sound in air varies with the temperature of the air. At sea level, with ambient temperature about 60°F, the speed of sound is around 760 miles per hour. If you measure it at the top of the troposphere (about 10 miles up), the speed is only around 660 mph. At higher elevations, it then increases (800 mph+).

Regarding guided missiles, we are concerned with four speed regions.

1. **Subsonic**— the region in which airflow over all missile surfaces is less than the local speed of sound. The subsonic region starts at Mach 0 and extends to about .75 Mach.

2. **Transonic**— the region in which airflow over the missile surfaces is mixed; subsonic in some areas, higher in others. The limits of this region are not sharply defined but range between .75 Mach and Mach 1.2.

3. **Supersonic**— the region in which airflow overall missile surfaces is at speeds greater than the local speed of sound. This region extends from about Mach 1.2 upward.

4. **Hypersonic**— speeds on the order of Mach 10 and higher.

Most SMS guided missiles are designed for use against supersonic air targets (anti-air warfare). These missiles normally travel in the Mach 2 to 2.5 range. Other SMS guided missiles, especially those designed only for use against surface targets (like Harpoon), travel in the subsonic region.

WARHEADS

LEARNING OBJECTIVE: Recall the types, purpose, and effectiveness of missile warheads, the types of fuzes, and the purpose of the safe and arming device.

Guided missile warheads are the business end of the missile. The basic warhead section consists of three functional elements—payload, fuze, and safety and arming (S&A) device. Variations in warhead design can be obtained by altering any one of the three elements since they are usually separate units. In other types of ammunition, like a gun projectile, the fuze and S&A device are combined into one single unit. The fuze function and S&A function are still performed separately but the device is known just as a fuze.

NOTE

In this text, we will refer to an S&A device as a safe and arming device. In other publications, you may see S&A (or S-A) defined as safety and arm, safeing and arming, and so forth. Functionally, all S&A devices are the same, only the name has changed. Don't be confused.

PAYLOADS

The primary element of the warhead is the payload. It is the destructive portion and accomplishes the end result of the missile. The text will examine the following types of payloads: blast and fragmentation.

Blast-Effect Warheads

A blast-effect warhead consists of a quantity of high explosives in a metal case. The force of the explosion creates a pressure or shock wave in the air or surrounding medium. It is this pressure wave that causes damage to the target.

Blast-effect warheads are most effective against underwater targets. Because water is incompressible and relatively dense, the effect of the blast is essentially magnified. A blast-effect warhead is also fairly successful against a ground or surface target. A blast-effect warhead is least effective against an air target. Air is not that dense and the shock wave dissipates quickly as it expands outward.

In all applications, timing is a predominant factor for blast-effect warheads. Figure 9-23 illustrates this point.

Fragmentation Warheads

Fragmentation warheads use the force of a high-explosive charge to break up the container or casing of the warhead. These "fragments" are then hurled outward as many high-speed pieces to cause damage to a target. The design and construction of a warhead can control the size, the velocity, and the pattern of fragment dispersion.

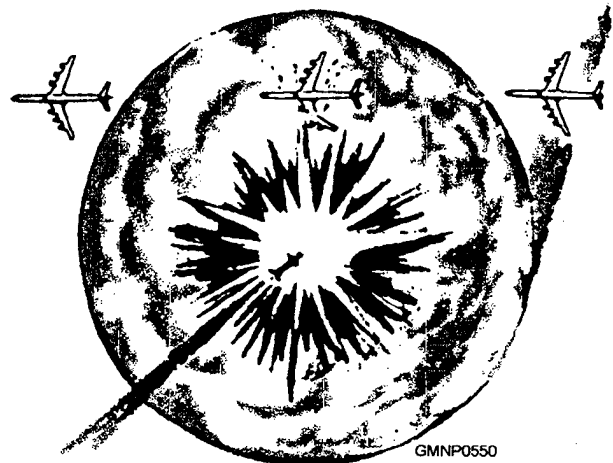

Figure 9-23.—A blast-effect warhead.

Fragmentation warheads are most effective against air targets. They can have a greater miss distance than a blast-effect warhead and do not have to make actual contact with the target. There are many design variations of fragmentation warheads. In SMS guided missiles, a popular fragmentation-style warhead is known as the continuous rod warhead. (See fig. 9-24.)

Early experiments with short, straight, unconnected rod warheads (view A of fig. 9-24) had shown that they could inflict serious damage to an air target. They could chop off propeller blades, penetrate engine blocks, slice up wings, and so forth. However, as airplanes got bigger, their structures were designed so they could receive a number of small "hits" and keep on flying. But, a long continuous cut in their structure was "bad news," and that's what a "continuous" rod warhead will do.

The continuous rod warhead is packaged in two bundles inside the missile. At detonation, a high-explosive force (inside the bundles) causes them to expand outward. (See view B of fig. 9-24.) The rods expand radially into a ring pattern which lengthens and increases in diameter. Generally, two semicircles are formed as the rods expand. (See view C of fig. 9-24.) These semicircles prevent disintegration of the pattern when maximum expansion is reached.

The expansion action can be likened to unfolding a carpenter's rule. The effect of these metal rods is a cutting action. If you've ever run into a clothesline while riding your bicycle, you can clearly understand this principle !

FUZES

The fuze is the second element of a warhead of a missile. The primary purpose of the fuze is to initiate detonation of the payload. To be effective, detonation or "fuzing" must occur at a point where maximum damage will be inflicted on the target. This point is often called the "optimum time of detonation." It is the job of the fuze to determine this time or point, which is based on the nature of the target and the attack geometry involved.

A large variety of fuze types is available. Three general classes are contact (impact), proximity, and ambient. The fuze type for a given application depends on the characteristics of the target, the missile, and the warhead. In guided missiles, the fuze is generally referred to as a target detection device (TDD). Some guidance systems produce or gather much or all the

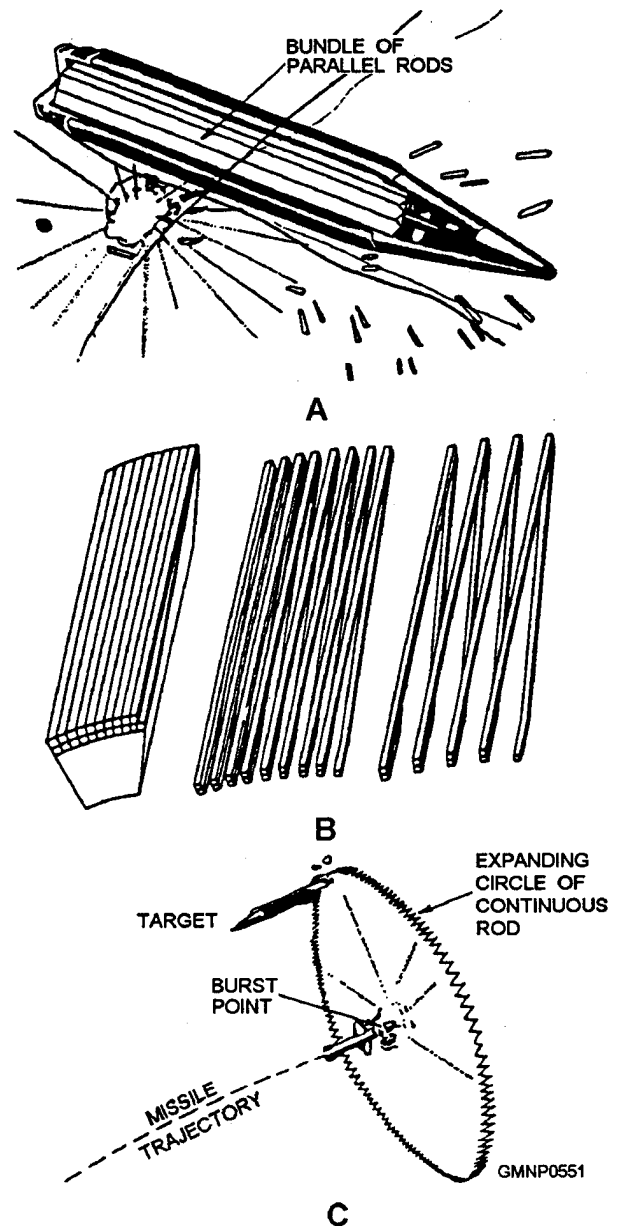

Figure 9-24.—View A.—an unconnected rod warhead; View B.—a continuous rod warhead bundle and its expanding action; View C.—the continuous rod warhead's circular pattern and cutting action.

information required to make the fuze function. In other cases, the TDD itself provides this information.

Contact Fuzes

Contact or impact fuzes are actuated by the inertial force that occurs when the missile strikes the target. Figure 9-25 illustrates the action of a contact fuze before and after impact. (The booster charge and main charge are not part of the fuze.)

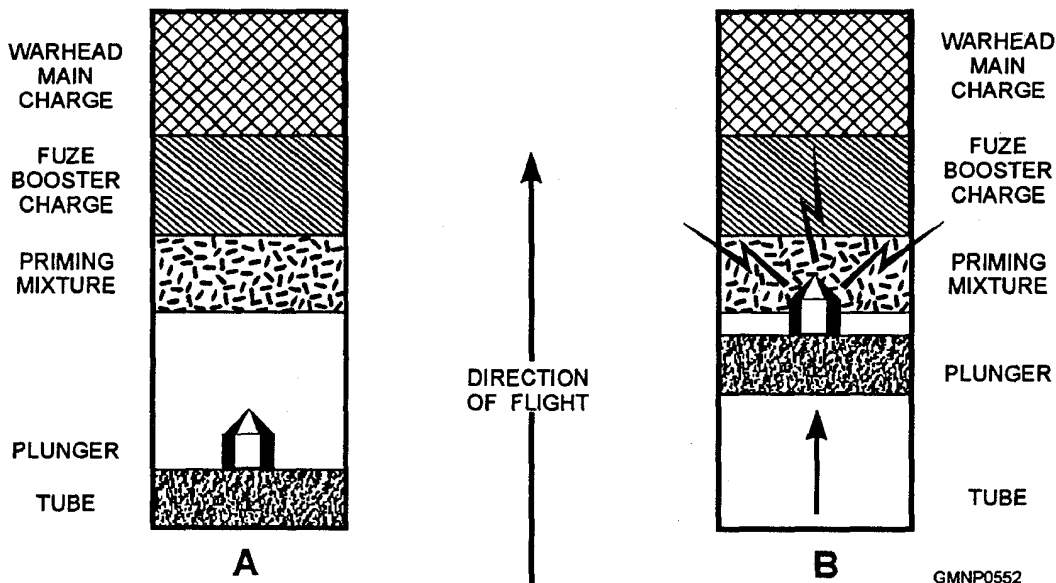

Figure 9-25.—Contact fuze action: A. Before impact; B. After impact.

During the launch and flight of the missile, the plunger remains in the after end of the fuze. When the missile strikes the target, it decelerates rapidly. The inertia of the plunger carries it forward to strike the sensitive priming mixture. The primer detonates and starts a chain reaction by igniting the fuze booster charge which ignites the main charge.

Sometimes a time delay element is used with a contact fuze. This delay permits the warhead to penetrate the target before detonation. Quite often a contact fuze is also used in conjunction with another type of fuze. For example, the main fuze can be a proximity-type fuze. Should it fail to operate as the missile approaches the target, the contact fuze would still function on impact. In this sense, a contact fuze serves as a backup or secondary fuze,

Proximity Fuzes

Proximity fuzes are actuated by some characteristic feature, influence, or property of the target or target area. Several types of proximity fuzes are available. The influence may be photoelectric, acoustic, pressure, electromagnetic (radio and radar), or electrostatic. Each of these influences could be preset to function when the intensity of the target characteristic reaches a certain magnitude.

Proximity fuzes are designed to initiate warhead detonation as the missile approaches or nears the target. The resulting burst pattern occurs at the most effective time and location relative to the target. Designing a fuze to produce an optimum burst pattern is not that easy. The most desirable pattern depends largely on the relative speed of the missile and of the target. Sometimes the fire control computer (during preflight programming) can adjust the sensitivity of the fuze. This action can compensate for varying target speeds and sizes. (We'd want a more sensitive fuze for a small target compared to a less sensitive fuze for a larger target.) Proximity fuzes, therefore, activate the warhead detonating system after computing two factors: (1) the distance to the target and (2) the rate at which missile-target range is closing.

Since a proximity fuze operates on the basis of information received from the target, it is subject to jamming. If jammed, the fuze could become inoperative. The missile would only damage the target if a direct hit (contact fuze) were scored. More seriously, jamming the fuze could result in premature detonation. In that case, the missile has no chance to reach the target. Most proximity fuzes use some means of electronic countermeasure or counter-countermeasure to eliminate or bypass the effects of jamming.

Of all the types of influence available (i.e., photoelectric, acoustic, pressure, etc.), the electromagnetic methods (radio and radar) are most practical. The TDD (fuze) transmits high-frequency

energy waves toward the target (fig. 9-26). Some of the waves are reflected from the target. Because the missile is constantly closing on the target, the reflected signal is of a higher frequency than the transmitted signal. The two signals, when mixed, will generate what is called a Doppler frequency. Its amplitude is a function of target distance. When the amplitude reaches a predetermined level, the fuze is programmed to operate and warhead detonation is initiated.

Ambient Fuzes

An ambient fuze is one that is activated by some characteristic of the environment surrounding the target. Ambient fuzes are used mainly for surface or subsurface applications. A simple example involves a hydrostatic fuze for underwater detonation. In this case, the fuze is basically a depth meter and activates when water pressure reaches a certain amount.

Command Fuzes

A command fuze responds to some form of signal from a remote control point. In guided missiles, this type of fuze is often used to order the weapon to self-destruct. The remote control point would be the firing ship. If the trajectory of the missile goes “wild” and/or the flight path endangers friendly forces, the firing ship orders command-destruct.

Other types of self-destroying fuzes are designed to actuate under certain conditions. For example, the missile can “lose sight” of the target. That may occur if some internal component malfunctions or the fire control radar ceases to transmit. Regardless of cause, the missile cannot respond to guidance data. If the

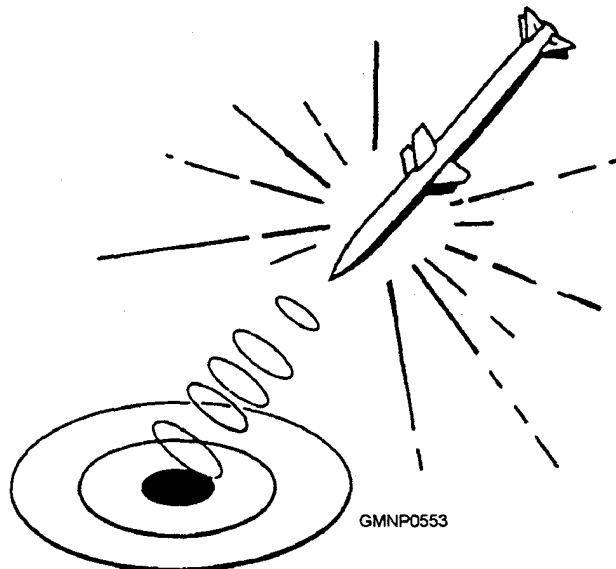

Figure 9-26.—A proximity fuze.

problem cannot be corrected rather quickly, circuits within the missile activate its self-destruct fuze.

SAFE AND ARMING DEVICE

The safe and arming (S&A) device is the third element of a warhead. Throughout a guided missile, there are many S&A-type devices. The one we are discussing here is related to the warhead and operates in conjunction with the fuze or TDD.

Fuze action may be divided into two phases—functioning and S&A. The functioning process involves initiating payload detonation at the optimum time, thus inflicting maximum damage. The S&A device has a dual purpose. As a safety feature, it must prevent premature initiation of the payload. The safety is effective until a specific signal or series of signals is received. At this time, certain events have occurred in correct sequence or (maybe) a desired time interval has elapsed. In any case, it is now safe to arm the warhead.

For the arming feature, the arming mechanism of the S&A device must actuate. This actuation removes or cancels the safety feature and permits the transfer of energy between the fuze and payload.

Normally, the safety function is accomplished by inserting a physical barrier between the fuze and payload. The S&A device thus acts as an open switch until safe detonation can be performed. Armed, the switch is closed and the explosive train is capable of activating.

Study figure 9-27 for a moment. It depicts atypical explosive train for a warhead and illustrates the relationship between the fuze (TDD), S&A device, and payload.

SMS GUIDED MISSILES

LEARNING OBJECTIVE: Recall the types, capabilities, and uses of SMS guided missiles.

We will show and provide a brief description of the various guided missiles launched from SMS GMLs on naval ships in the fleet. Some of these weapons are capable of being launched from aircraft and submarines too. For the most part, SMS guided missiles are designed to be used against air targets. However, several missiles in our SMS arsenal can engage surface, underwater, and land targets.

The Standard missile (fig. 9-28) represents the largest group of guided missiles in the SMS arsenal used

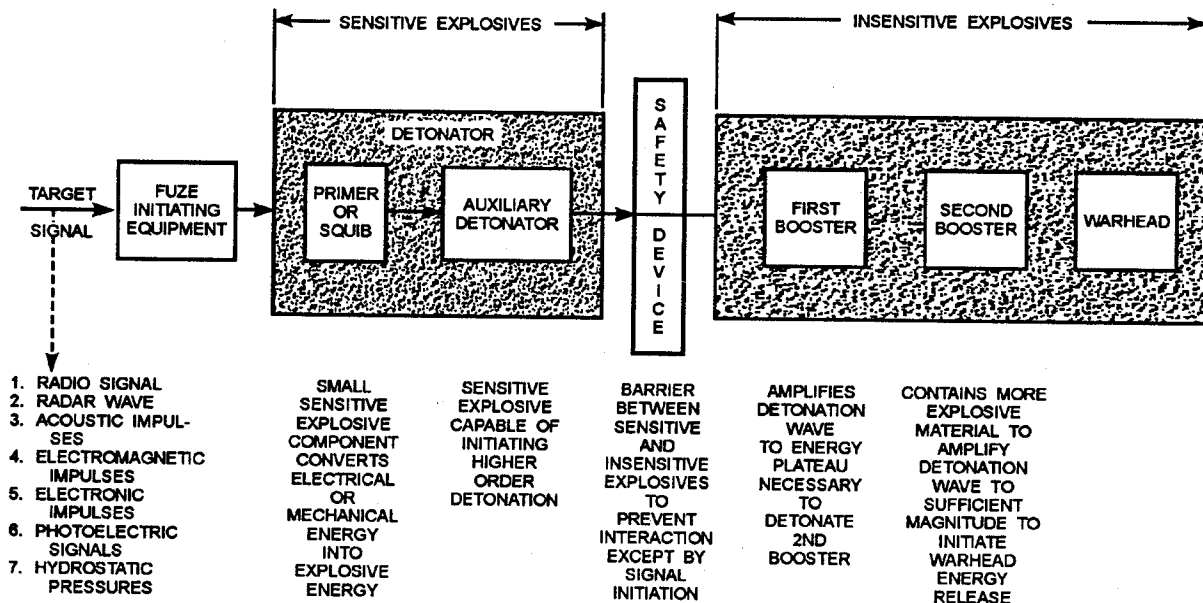

GMNP0554

Figure 9-27.—Schematic of typical explosive train with safety device.

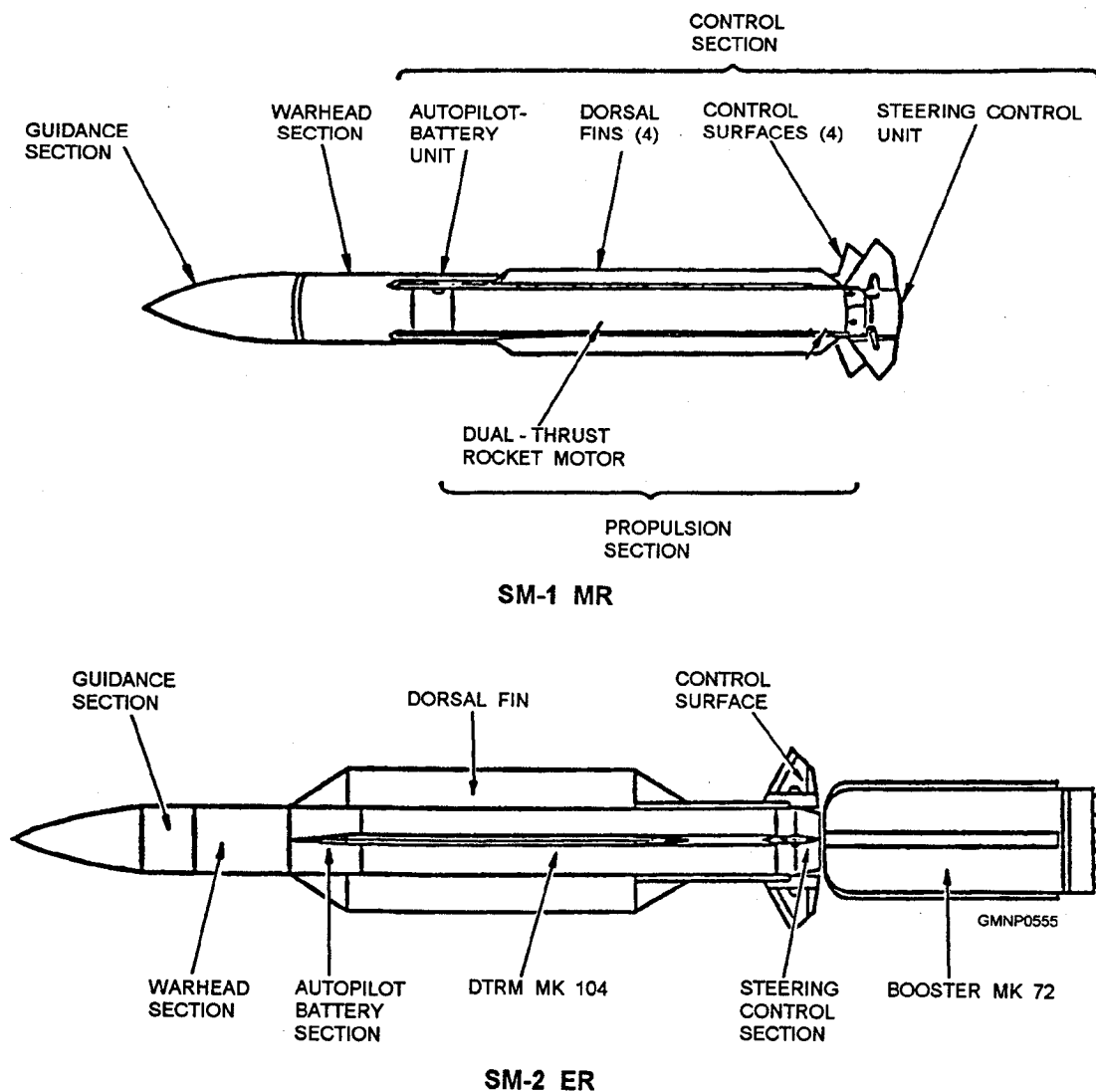

Figure 9-28.—SM-1 MR and SM-2 ER major sections, components, and physical configuration.

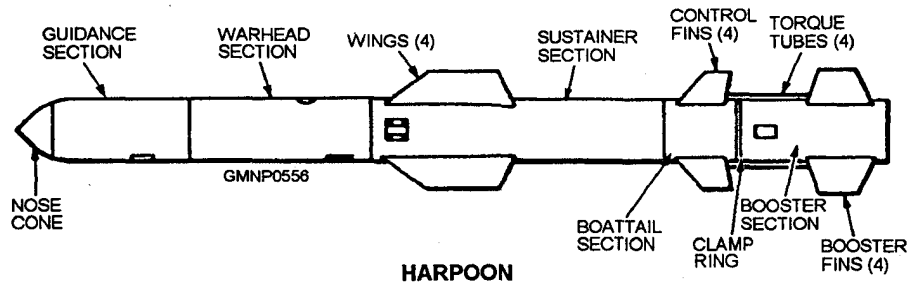

Figure 9-29.—Harpoon missile.

primarily against air targets. The popular designation of the missile is expressed as SM-1 MR medium-range missile and SM-2 ER extended range missile. SM-2 missiles are used on vertical launching system (VLS) ships.

The Harpoon missile (fig. 9-29) is a subsonic, low altitude cruise missile for use against surface targets only. It is equipped with a self-contained midcourse (cruise) guidance system and uses advanced active homing techniques with countermeasure capabilities.

Harpoon is designed as an all-up-round (AUR) for all weather operations and is capable of engaging over-the-horizon targets.

Tomahawk cruise missile (fig. 9-30) is a long-range, subsonic, land-attack, and anti-ship missile with a solid propellant booster and a liquid propellant turbofan engine.

Missiles are identified by various methods. The military designation method is shown in table 9-1. The missile is classified as to its launch environment,

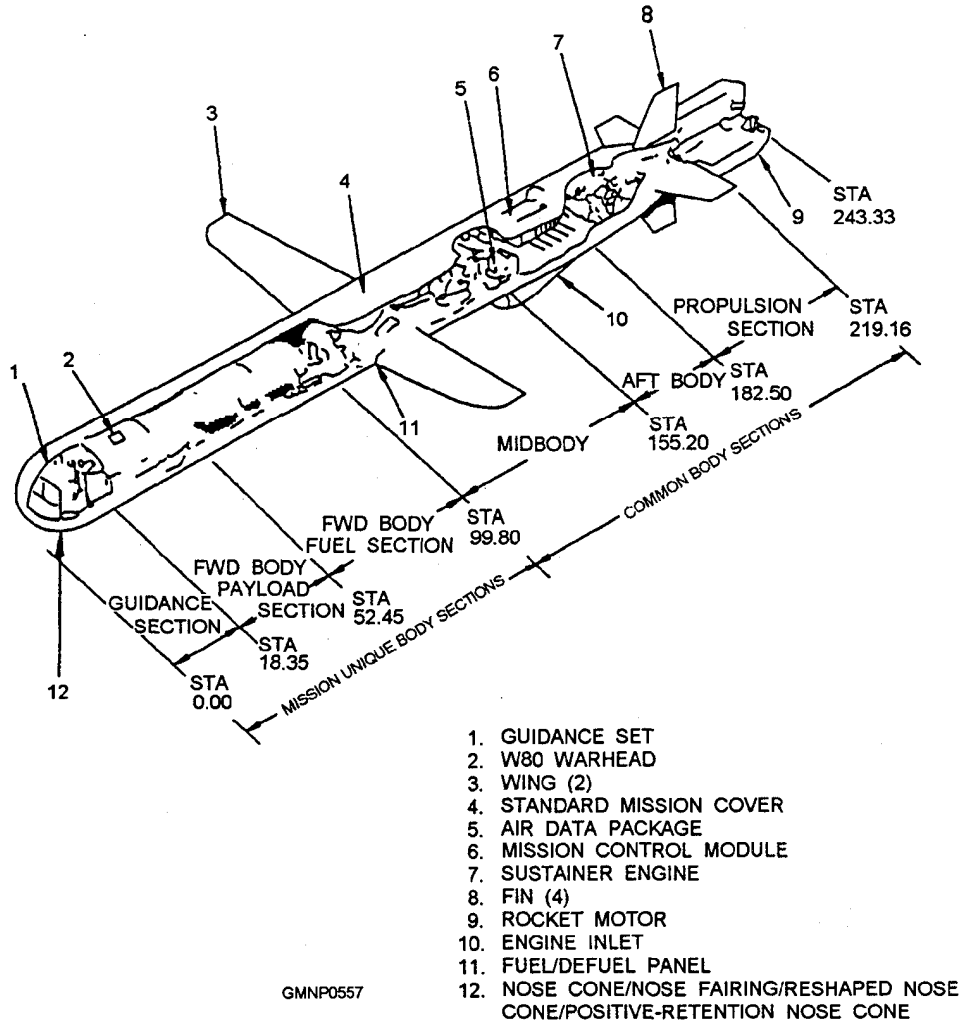

Figure 9-30.—Tomahawk cruise missile.

Table 9-1.—Missile categories

LAUNCH ENVIRONMENT SYMBOLS		
Letter	Title	Description
A	Air	Air launched.
B	Multiple	Capable of being launched from more than one environment.
C	Coffin	Stored horizontally or at less than a 45 degree angle in a protective enclosure (regardless of structural strength) and launched from the ground.
H	Silo Stored	Vertically stored below ground level and launched from the ground.
L	Silo Launched	Vertically stored and launched from below ground level.
M	Mobile	Launched from a ground vehicle or movable platform.
P	Soft Pad	Partially or nonprotected in storage and launched from the ground.
R	Ship	Launched from a surface vessel, such as ship, barge, etc.
U	Underwater	Launched from a submarine or other underwater device.

MISSION SYMBOLS

D	Decoy	Vehicles designed or modified to confuse deceive, or divert enemy defenses by simulating an attack vehicle.
E	Special Electronic	Vehicles designed or modified with electronic equipment for communications, countermeasures, electronic radiation sounding, or other electronic recording or relay missions.
G	Surface Attack	Vehicles designed to destroy land or sea targets.
I	Intercept-Aerial	Vehicles designed to intercept aerial targets, defensive or offensive roles.
Q	Drone	Vehicles designed for target, reconnaissance, or surveillance purposes.
T	Training	Vehicles designed or permanently modified for training purposes.

U	Underwater Attack	Vehicles designed to destroy enemy submarines or other underwater targets or to detonate underwater.
W	Weather	Vehicles designed to observe, record, or relay meteorological data.

VEHICLE TYPE SYMBOLS

M	Guide Missile	Unmanned, self-propelled vehicles designed to move in a trajectory or flight path all or partially above the earth's surface and whose trajectory or course, while the vehicle is in motion, can be controlled remotely or by homing systems, or by inertial and/or programmed guidance from within. This term does not include space vehicles, space boosters, or naval torpedoes, but does include target and reconnaissance drones.
N	Probe	Non-orbital instrumented vehicles not involved in space missions that are used to penetrate the aerospace environment and report information.
R	Rocket	Self-propelled vehicles without installed or remote control guidance mechanisms, whose trajectory cannot be altered after launch. Rocket systems designed for line of sight are not included.

The military designation of the ASROC missile is RUR-5A since it is a ship-launched rocket designed to destroy enemy submarines. It is the first (A) of its assigned design number (5).

If necessary, to denote a special status, one of the following letters is affixed before the military designation.

STATUS PREFIX SYMBOLS

J	Special Test (Temporary)	Vehicles especially configured simply to accommodate test.
N	Special Test (Permanent)	Vehicles so modified they will not be returned to original use.
X	Experimental	Vehicles under development.
Y	Prototype	Preproduction vehicles for test.
Z	Planning	Vehicles in planning stage.

mission, and vehicle type. For example, a RIM designation represents a ship-launched guided missile designed to intercept air targets.

A type and configuration letter-number combination can be added to the basic designation. For example, RIM-66A identifies a STANDARD SM-1A missile. An RGM-84A identifies a ship-launched surface attack guided missile or the HARPOON missile.

SUMMARY

In this chapter we have discussed the missile basic systems, the principles of guided missiles, and the SMS guided missiles. We covered

1. Structures—or the airframe,

2. Control systems—with references to aerodynamics and how flight attitude or stability was controlled,

3. Guidance systems—with references to various types (command, homing, and self-contained) and how they interact with the control system to control flight trajectory,

4. Propulsion—with references to air-breathing jet engines (turbojets) and solid-fuel rocket motors,

5. Warheads—with references to the payload, fuze, and S&A device, and

6. SMS guided missiles—used on surface launched ships.

For specific and detailed discussions of particular systems, refer to system technical manuals and the references cited in an appendix to this TRAMAN.